



## 5mm Infrared LED ,T-1 3/4

MODEL NO : IR333/F19-8

### ■ Features :

- High radiant intensity
- Peak wavelength  $\lambda_p=940\text{nm}$
- View angle  $20^\circ$
- High reliability
- 2.54mm Lead spacing

### ■ Description :

- EVERLIGHT's Infrared Emitting Diode (IR333/F19-8) is a high intensity diode, molded in a blue transparent plastic package.  
The device is spectrally matched with phototransistor, photodiode and infrared receiver module.

### ■ Applications :

- Free air transmission system
- Optoelectronic switch
- Floppy disk drive
- Infrared applied system
- Smoke detector

PART NO.	CHIP	LENS COLOR
	MATERIAL	
IR	GaAlAs	Blue

## 5mm Infrared LED ,T-1 3/4

MODEL NO : IR333/F19-8

### ■ Package Dimensions :

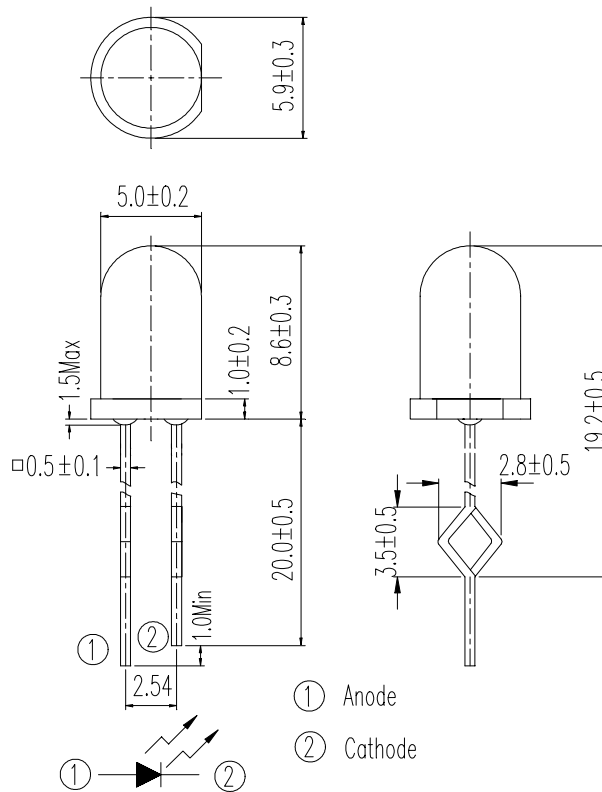

### ■ Notes :

- All dimensions are in millimeter.
- Protruded resin under flange 1.5 mm Max.
- Lead spacing is measured where the lead emerge from the package.
- Lens color : Blue transparent.
- Above specification may be changed without notice. EVERLIGHT will reserve authority on material change for above specification.
- These specification sheets include materials protected under copyright of EVERLIGHT corporation . Please don't reproduce or cause anyone to reproduce them without EVERLIGHT's consent.
- When using this product , please observe the absolute maximum ratings and the instructions for use outlined in these specification sheets. EVERIGHT assumes no responsibility for any damage resulting from use of the product which does not comply with the absolute maximum ratings and the instructions included in these specification sheets.



## 5mm Infrared LED ,T-1 3/4

MODEL NO : IR333/F19-8

### ■ Absolute Maximum Ratings at T<sub>A</sub> = 25°C

Parameter	Symbol	Rating	Unit	Notice
Continuous Forward Current	I <sub>F</sub>	100	mA	
Peak Forward Current Pulse width=100 μs, Duty cycle=1%	I <sub>FP</sub>	1.0	A	
Reverse Voltage	V <sub>R</sub>	5	V	
Operating Temperature	Topr	-40 ~ +85	°C	
Storage Temperature	Tstg	-40 ~ +85	°C	
Soldering Temperature	Tsol	260	°C	4mm from mold body less than 5 seconds
Power Dissipation at(or below) 25°C Free Air Temperature	Pd	150	mW	

### ■ Electronic Optical Characteristics :

Parameter	Symbol	Min.	Typ.	Max.	Unit	Condition
Radiant Intensity	Ee	7.8	20	----	mW/sr	I <sub>F</sub> =20mA
		----	85	----		I <sub>F</sub> =100mA, tp=100 μs, t <sub>p</sub> /T=0.01
		----	750	----		I <sub>F</sub> =1A, tp=100 μs, t <sub>p</sub> /T=0.01
Peak Wavelength	λ <sub>P</sub>	----	940	----	nm	I <sub>F</sub> =20mA
Spectral Bandwidth	Δλ	----	45	----	nm	I <sub>F</sub> =20mA
Forward Voltage	V <sub>F</sub>	----	1.2	1.5	V	I <sub>F</sub> =20mA
		----	1.4	1.8		I <sub>F</sub> =100mA, tp=100 μs, t <sub>p</sub> /T=0.01
		----	2.6	4.0		I <sub>F</sub> =1A, tp=100 μs, t <sub>p</sub> /T=0.01
Reverse Current	I <sub>R</sub>	----	----	10	μA	V <sub>R</sub> =5V
View Angle	2θ1/2	----	20	----	deg	I <sub>F</sub> =20mA



## 5mm Infrared LED ,T-1 3/4

MODEL NO : IR333/F19-8

### ■ Typical Electrical/Optical/Characteristics Curves

Fig. 1 Forward Current vs. Ambient Temperature

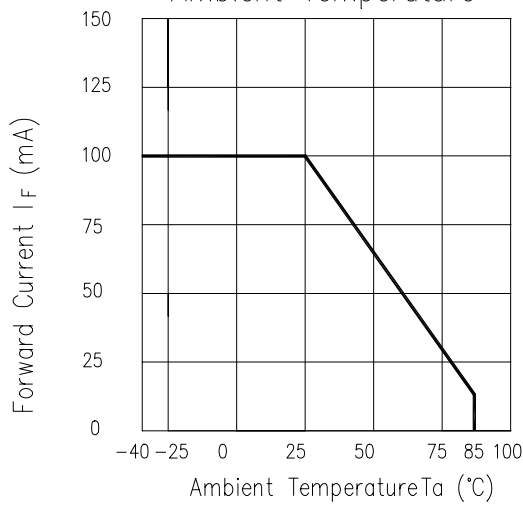

Fig. 2 Spectral Distribution

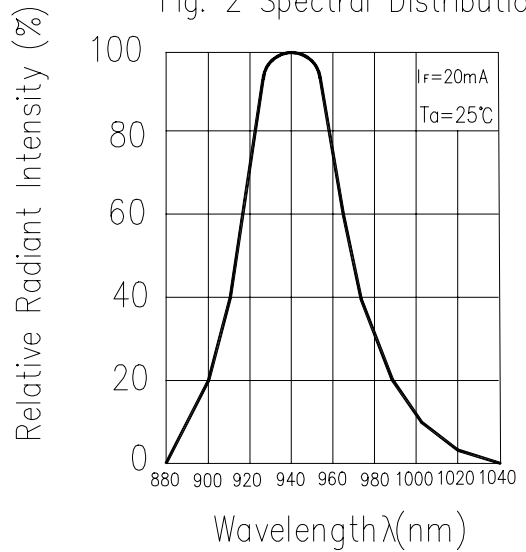

Fig. 3 Peak Emission Wavelength vs. Ambient Temperature

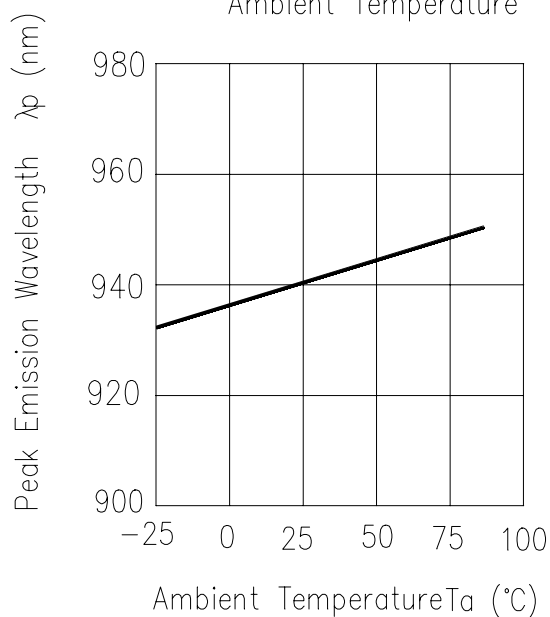
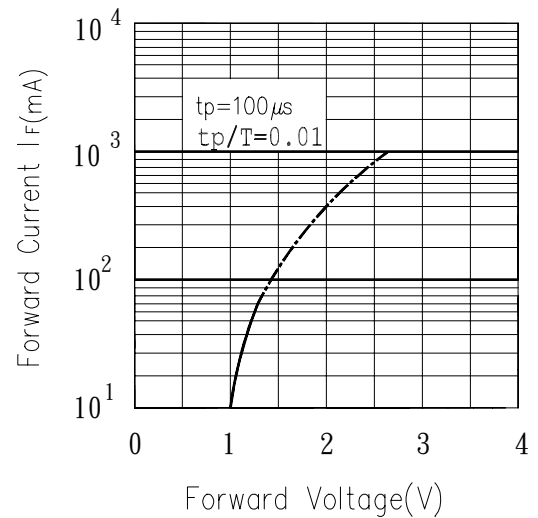

Fig. 4 Forward Current vs. Forward Voltage





5mm Infrared LED ,T-1 3/4

MODEL NO : IR333/F19-8

■ Typical Electrical/Optical/Characteristics Curves

Fig. 5 Relative Intensity vs. Forward Current

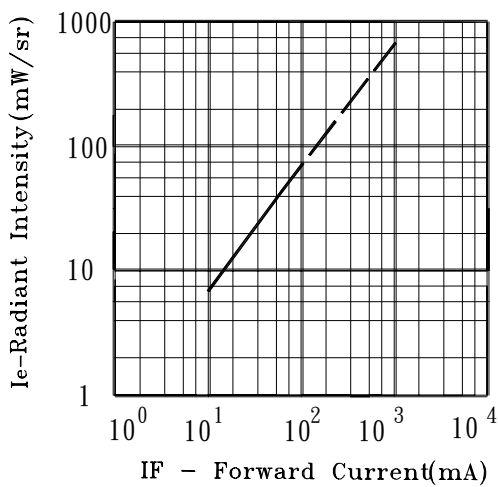

Fig. 6 Relative Radiant Intensity vs. Angular Displacement

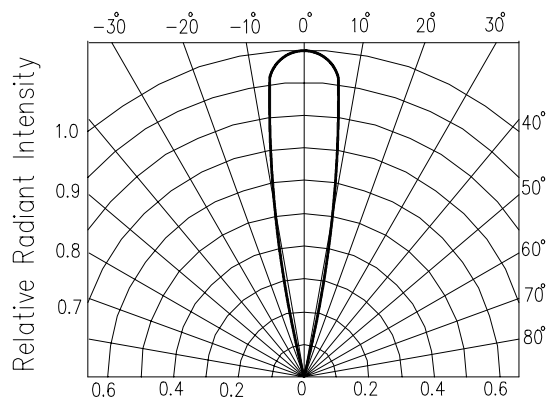

Fig. 7 Relative Intensity vs. Ambient Temperature (°C)

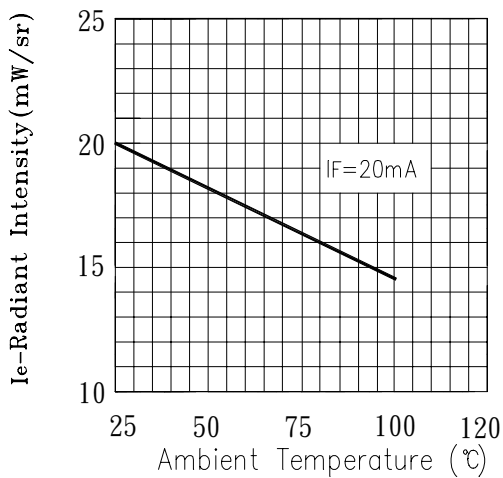
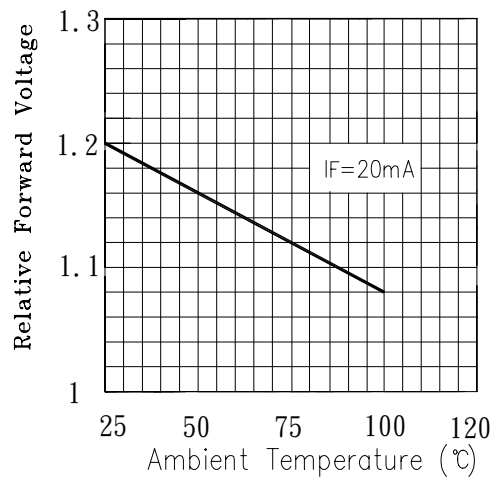

Fig. 8 Forward Current vs. Ambient Temperature (°C)





# EVERLIGHT ELECTRONICS CO., LTD.

DEVICE NUMBER : DIR-033-151      REV : 1.2  
 ECN : \_\_\_\_\_      PAGE : 6/8

## 5mm Infrared LED ,T-1 3/4

MODEL NO : IR333/F19-8

### ■ Reliability Test Item And Condition

The reliability of products shall be satisfied with items listed below.

Confidence level:90%

LTPD:10%

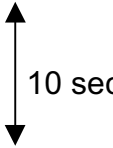
NO.	Item	Test Conditions	Test Hours/ Cycles	Sample Sizes	Failure Judgement Criteria	Ac/Re
1	Solder Heat	TEMP : 260°C ± 5 °C	5 secs	22 pcs		0/1
2	Temperature Cycle	H : +85°C    30 mins  L : -55°C    30 mins	50 cycles	22 pcs	$I_R \geq U \times 2$ $E_e \leq L \times 0.8$ $V_F \geq U \times 1.2$	0/1
3	Thermal Shock	H : +100°C    5 mins  L : -10°C    5 mins	50 cycles	22 pcs	U :Upper specification limit L :Lower specification limit	0/1
4	High Temperature Storage	TEMP. : +100°C	1000 hrs	22 pcs		0/1
5	Low Temperature Storage	TEMP. : -55°C	1000 hrs	22 pcs		0/1
6	DC Operating Life	$I_F = 20\text{mA}$	1000 hrs	22 pcs		0/1
7	High Temperature / High Humidity	85°C / 85% R.H.	1000 hrs	22 pcs		0/1



DEVICE NUMBER : DIR-033-151    REV : 1.2  
ECN : \_\_\_\_\_    PAGE : 7/8

## 5mm Infrared LED ,T-1 3/4

MODEL NO : IR333/F19-8

### ■ Test Method For Power :

Condition :  $I_F=20\text{ mA}$

Test Item : Radiant Intensity

Unit : mW/sr

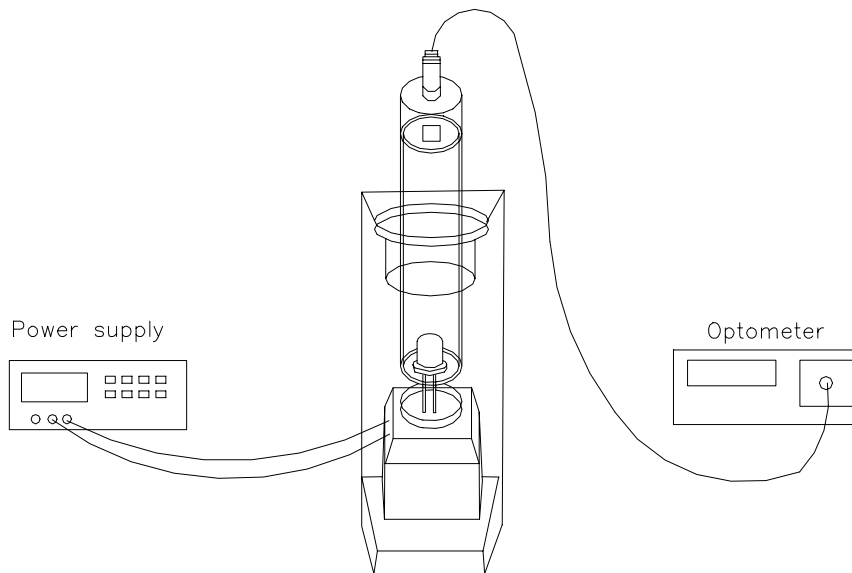

### ■ To Distinguish Intensity:

Condition:  $I_F=20\text{mA}$

Unit : mW/sr

Bin Number	M	N	P	Q
Min	7.80	11.00	15.00	21.00
Max	12.50	17.60	24.00	34.00



## 5mm Infrared LED ,T-1 3/4

MODEL NO : IR333/F19-8

### ■ Packing Specifications

1. Bag

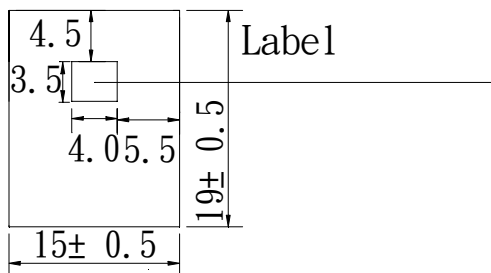

2. Box

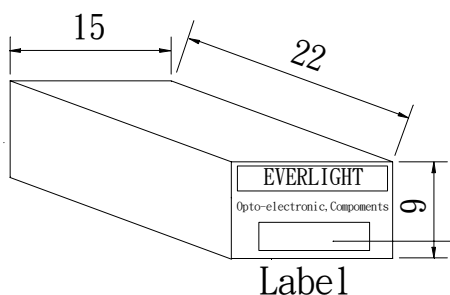

EVERLIGHT

CPN:

P/N:



IR333/F19-8

QTY:

CAT:

HUE:

REF:

LOT NO:



MADE IN TAIWAN

3. Carton

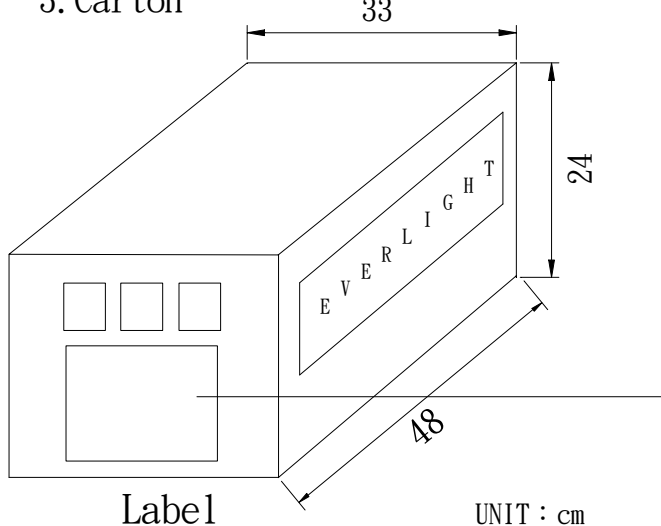

Label

UNIT : cm

CPN : Customer's Production Number

P/N : Production Number

QTY : Packing Quantity

CAT : Ranks

HUE : Peak Wavelength

REF : Reference

LOT NO : Lot Number

MADE IN TAIWAN : Production place

### ■ Packing Quantity Specification

1. 500 Pcs/1Bag , 6 Bags/1Box

2. 10 Boxes/1Carton